



Power Meter Monitor

**Business and Mission-
Critical Solutions Provider**

COMPACT ARM BASED EMBEDDED INDUSTRIAL COMPUTER

Data Sheet



Model: PMM0103

Document: Data Sheet

Document version: 1.6

Date: November 2020



COPYRIGHT NOTICE

The information in this document is subject to change without prior notice to improve reliability, design, and function and does not represent a commitment on the part of the manufacturer.

In no event will the manufacturer be liable for direct, indirect, special, incidental, or consequential damage arising out of the use or inability to use the product or documentation, even if advised of the possibility of such damages.

This document contains proprietary information protected by copyright. All rights are reserved. No part of this manual may be reproduced by any mechanical, electronic, or other means in any form without prior written permission of the manufacturer.

TRADEMARKS

All registered trademarks and product names mentioned herein are used for identification purposes only and may be trademarks and/or registered trademarks of their respective owners.

AMI is a trademark of American Megatrends Inc.

Intel & Atom are trademarks of Intel Corporation

IBM, PC/AT, PS/2&VGA are trademarks of International Business Machines Corporation
Microsoft Windows is a trademark of Microsoft Corp. RTL is the trademark of Realtek Semiconductor Co., Ltd.

DECLARATION OF CONFORMITY

This restriction is subject to protect the operational process of the system in the business environment, which will produce, use, and transmit radiofrequency energy. Harmful interference to radio communication could result if instructions to the correct installation and usage were not applied. The interference prevention cannot be guaranteed even with proper installation according to the manual. If the device causes a bad effect on the radio / TV signal. The user could preclude that by turning the device on/off.

When this device produces some harmful interference, the user can use the following measure to solve the interference problem:

1-Setting the receiving antenna's direction or location to increase the distance between this device and receiver.

2-Plug in the device's power connector into different circuits of the power outlet with the receiver.

3-If any technical support is needed, the dealer or experienced radio/TV technical personnel must be informed.

TECHNICAL SUPPORT AND SERVICE

Visit Pmm-usa.us to browse FAQs and get further details.

User should collect the following information before submitting technical support and service requests:

- Product name, model and serial number.
- Installed software (operating system, OS version, installed applications and so on).
- Full description of the problem
- Detailed information about every error.

SAFETY INSTRUCTIONS

- Only trained and qualified personnel can install, operate, or maintain the device.
- Before starting the installation, all safety precautions must be read and warning labels affixed to the device must be observed. Doing so protects the device from damage and ensures your safety.
- Safety precautions provided in this document may not cover all safety aspects, note to always remain mindful of safety.
- PMM is not liable for any consequence that results from violation of regulations pertaining to safe operations or safety codes pertaining to design, production, and equipment usage.
- DO NOT use liquids or decontamination spray to clean the device surface and assure that it is totally disconnected while cleaning.
- Take all measures to prevent device drop before or during installation.
- Prior to connecting the device to power source, ensure the source and device voltage and power are 100% matched.
- Keep the cables in a suitable covered place.
- If the device is not used for a long time, shut off the power to avoid the damages by transient overvoltage.
- DO NOT allow any liquid flow into the device; to avoid fire or short circuit.
- The recommended storage temperature range should NOT be less than 30°C OR higher than 85°C.



Warning:

- Read the power source and device inlet carefully.
- Handle device with both hands.
- Clean and maintain the device using recommended, safe and suitable methods.



Caution:

If any unauthorized changes of settings or repairs are done without PMM approval; then user's rights of controlling this device will be canceled.



CONTENTS

PAGE

KEY FEATURES	4
TARGET APPLICATION	4
DESCRIPTION	4
TECHNICAL SPECIFICATIONS	5
ENCLOSURE ASSEMBLY INFORMATION	6
ENCLOSURE DIMENSIONS	7
ORDERING INFORMATION	8

KEY FEATURES

- Allwinner H3, Quad-core Cortex-A7 CPU
- 512MB RAM and Embedded 8GB eMMC hard drive
- 2x Ethernet 10/100 ports
- Supports 2.4 WIFI
- Built-in 1x Rs485 COM port
- 3x customized serial/IO communication ports covering all industrial standards
- 1x USB2.0 Type A
- Ubuntu Core operating system
- Arduino® compatible programming
- Built to meet all harsh environment and Power substation requirements
- Wide range of power supply options
- -40 to 85°C system operating temperature
- Compact size with fanless design
- Wide range of mounting options
- Degree of protection: IP54

TARGET APPLICATION

PMM0103 rich features industrial-grade computers can provide long lasting and reliable operation with wide range of applications and already implemented on the following field applications:

- Factory and Machine automation
- Power plant controllers
- NTP timing servers
- SQL data banks
- Field data loggers
- Protocol and Media converters
- PV Tracker controller
- ...And many more.

DESCRIPTION

PMM0103 is a rugged powerful reliable fanless Linux based embedded industrial computer, powered by Allwinner H3 CPU, which offers high-performance processing with a high degree of functional integration.

The device represents an ideal computing solution for tight spaces, since it is highly compacted in size, designed with small footprints and multiple I/Os. Covered by a durable metal chassis which was designed and tested on the field to withstand shock, vibration, extended temperature ranges and challenging elements of a harsh environment.

PMM0103 offers the client a wide range of interfaces covering most of the industrial standards and increasing the connectivity.

Moreover, PMM0103 is especially designed to meet all power substation requirements and covers all field standards of power, reliability, easy configuration and long-lasting life.

TECHNICAL SPECIFICATIONS

Computer

CPU	Allwinner H3, Quad-core Cortex-A7 CPU
DRAM	512 DD3RAM
Storage	8GB eMMC
RTC CHIP	DS3231
Pre-installed OS	Ubuntu Core

Computer Interface

Ethernet	2x 10/100Base-T RJ45
USB	1x USB2.0 Type A 1x Micro USB
Wi-Fi	2.4 GHz
Serial	1x RS485
Optional Interface	16 pin connector on edge with following connectivity options (max 3 options can be chosen upon order to be factory pre-fitted) RS232 RS485 RS422 CAN bus Analogue Inputs Analogue Output Digital Inputs Digital Output
SD Slot	1x MicroSD card socket for user supplied card up to 64GB

Power Parameters

Power Supply Options	10-56 VDC 8-40 VAC 36-72 VDC 25-50 VAC 85-285 VAC / 100-300 VDC
Power Connector	Phoenix Contact 4pins 3.5mm

Physical Characteristics

Housing	Metal
Dimensions	3.93*3.93*1.45 inch (100*100*37 mm)
Mounting Options	Standard 35mm DIN Rail Direct Panel Mounting Front Panel Mounting 19" rack 1U
Certifications	RoHS, CE and FCC

ENCLOSURE ASSEMBLY INFORMATION

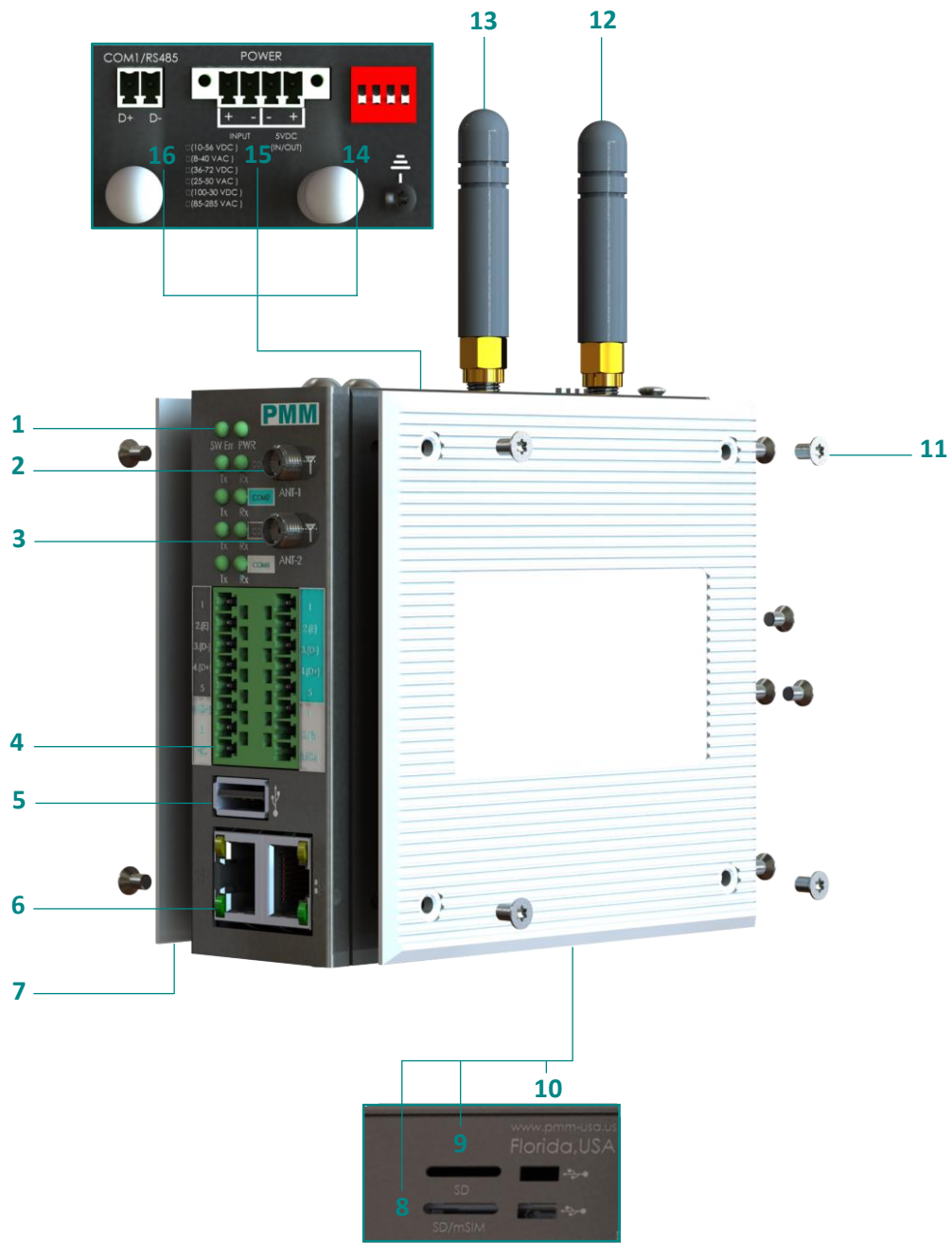

ITEM	DESCRIPTION
1	8x LED indicators
2	Antenna 1
3	Antenna 2
4	3x Serial interfaces
5	USB A interface
6	2x Ethernet ports
7	Heat sink
8	mSIM interface

9	SD interface
10	USB interface
11	Screw
12	Antenna 3
13	Antenna 4
14	Termination Resistor Selector RS485
15	Power inlet
16	RS485 interface

ENCLOSURE DIMENSIONS

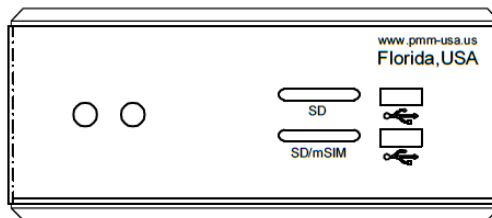
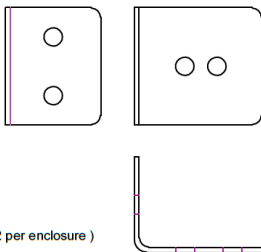
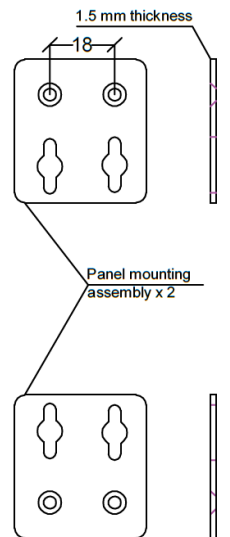
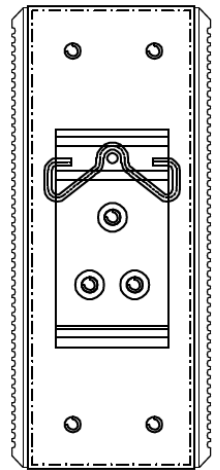
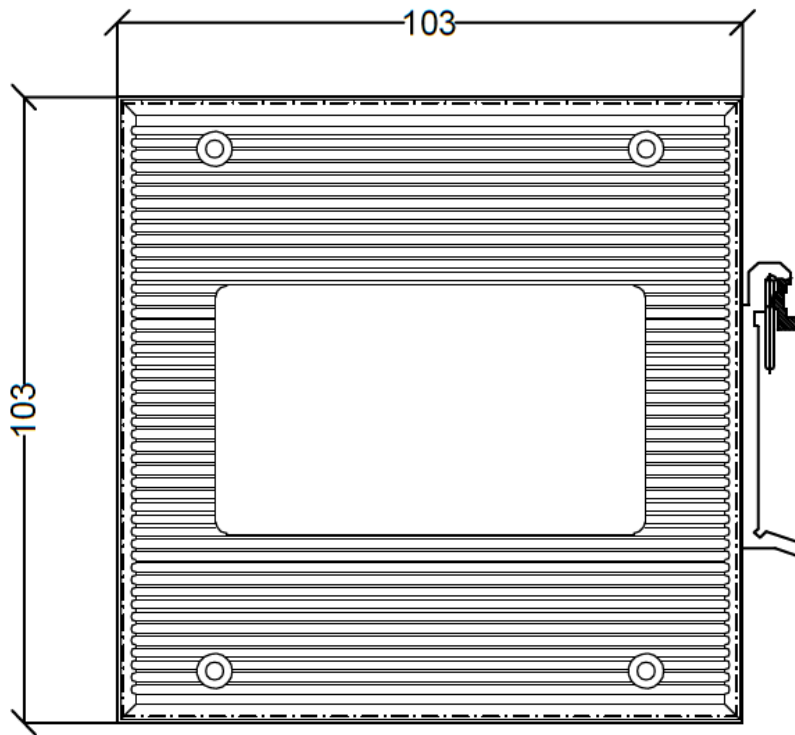
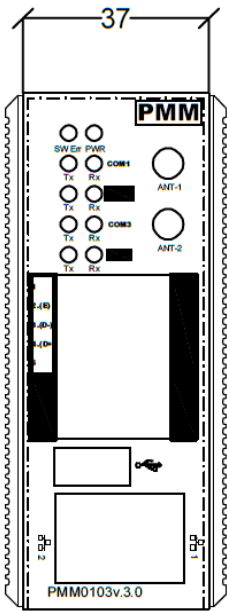
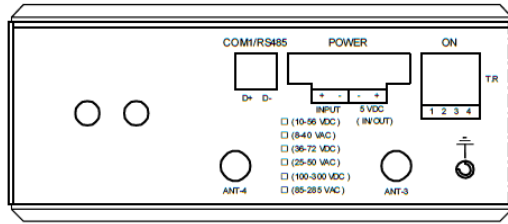

ORDERING INFORMATION

Order Configuration table																																	
PMM0103	-x	-09xx	-09xx	-09xx	Table1* Comm port options																												
Power supply					<table border="1"> <thead> <tr> <th colspan="2">COM Ports Options</th> </tr> </thead> <tbody> <tr> <td>Analog input</td> <td>PMM0901</td> </tr> <tr> <td>Analog output</td> <td>PMM0902</td> </tr> <tr> <td>CANBUS (UART)</td> <td>PMM0910</td> </tr> <tr> <td>CANBUS (UART)</td> <td>PMM0910i</td> </tr> <tr> <td>CANBUS (SPI)</td> <td>PMM00911</td> </tr> <tr> <td>CANBUS (SPI)</td> <td>PMM0911i</td> </tr> <tr> <td>RS485</td> <td>PMM0912</td> </tr> <tr> <td>RS422</td> <td>PMM0913</td> </tr> <tr> <td>RS422</td> <td>PMM0914</td> </tr> <tr> <td>RS232</td> <td>PMM0915</td> </tr> <tr> <td>LTE</td> <td>PMM0916</td> </tr> <tr> <td>Digital input</td> <td>PMM0920</td> </tr> <tr> <td>Digital output</td> <td>PMM0921</td> </tr> </tbody> </table>	COM Ports Options		Analog input	PMM0901	Analog output	PMM0902	CANBUS (UART)	PMM0910	CANBUS (UART)	PMM0910i	CANBUS (SPI)	PMM00911	CANBUS (SPI)	PMM0911i	RS485	PMM0912	RS422	PMM0913	RS422	PMM0914	RS232	PMM0915	LTE	PMM0916	Digital input	PMM0920	Digital output	PMM0921
COM Ports Options																																	
Analog input	PMM0901																																
Analog output	PMM0902																																
CANBUS (UART)	PMM0910																																
CANBUS (UART)	PMM0910i																																
CANBUS (SPI)	PMM00911																																
CANBUS (SPI)	PMM0911i																																
RS485	PMM0912																																
RS422	PMM0913																																
RS422	PMM0914																																
RS232	PMM0915																																
LTE	PMM0916																																
Digital input	PMM0920																																
Digital output	PMM0921																																
10-56 VDC	-1																																
8-40 VAC	-2																																
36-72 VDC	-3																																
25-50 VAC	-4																																
85-285 VAC/100-300 VDC	-5																																
COM Port 1																																	
RS485		-0912																															
CAN Bus		-0910																															
ANALOG INPUTS		-0901																															
DIGITAL INPUT		-0920																															
GSM/GPRS		-0917																															
<i>See the COM Ports table for more options</i>																																	
COM Port 2 (Same as COM Port 1 options)			-09xx																														
COM Port 3 (Same as COM Port 1&2 options)				-09xx																													

Accessories

DIN Mount (included)	DIN Rail Mounting Bracket
Wall Mounting Kit (included)	2x Wall Mounting Bracket
Panel Mounting Kit(optional)	2x Panel Mounting Bracket
Rack Mounting Kit (optional)	Rack Mounting Bracket

CONTACT INFORMATION:

- For direct inquiries or any customized orders, contact us on sales@Pmm-usa.us